

SHARP®

DW-J27FA

DW-J20FA

AIR PURIFYING DEHUMIDIFIER OPERATION MANUAL

ENGLISH

中文



HIGH-DENSITY 7000*

空氣淨化抽濕機 使用說明書

Device of this mark is a trademark of Sharp Corporation.
“Plasmacluster” and “Device of a cluster of grapes” are
trademarks of Sharp Corporation.

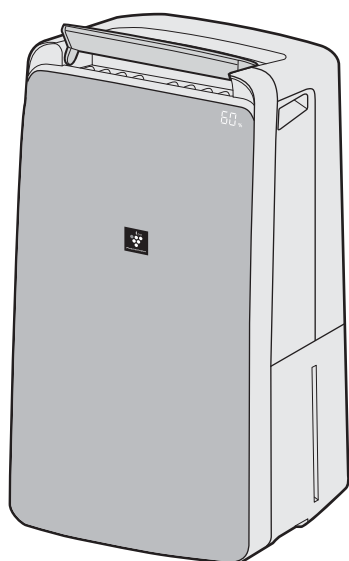

* The number in this technology mark indicates an approximate number of ions supplied into air of 1 cm³, which is measured around the center of a room with the “high-density plasmacluster 7000” applicable floor area (at 1.2 m height above the floor) when the product is placed close to a wall at the LAUNDRY Operation “DEODORIZE mode setting.

ENGLISH

Thank you for purchasing this SHARP Air Purifying Dehumidifier.
Please read this manual carefully before using the product.
This manual should be kept in a safe place for handy reference.

CONTENTS

IMPORTANT SAFETY INSTRUCTIONS	2
PART NAMES	4
PREPARATION	6
OPERATION	
START/STOP	6
DEHUMIDIFY OPERATION	7
HUMIDITY SELECT	7
LAUNDRY OPERATION	7
AIR PURIFY OPERATION	7
MOLD CONTROL OPERATION	8
TIMER OPERATION	8
SWING LOUVER	9
INTERNAL DRY OPERATION	9
CHILD LOCK.....	9
SELECTING DISPLAY	9
HOW TO CHANGE VARIOUS SETTING.....	10
HOW TO DRAIN	11
CARE AND MAINTENANCE	12
TROUBLESHOOTING	15
SPECIFICATIONS	16

Dehumidify

In accordance with the principle of generating water droplets when warm air with much moisture gets contact with cold items, wet air is blown in a evaporator to remove moisture.

In the following cases, the compressor will stop and will not dehumidify.

- When the room temperature is lower than 4°C or higher than 38°C.
- The 3 minutes when the Main Unit operated again in the following to protect the Main Unit.
 - * Immediately after the power plug is inserted.
 - * Immediately after the Laundry Drying/ Dehumidifying operation is stopped.
- When the room temperature falls below 18°C, the compressor will stop and "HIGH" air flow mode will operate for about 12 minutes once every 45 minutes to prevent frost damage inside the Main Unit. (DEFROST mode / The DEFROST Indicator Light is turned on.)

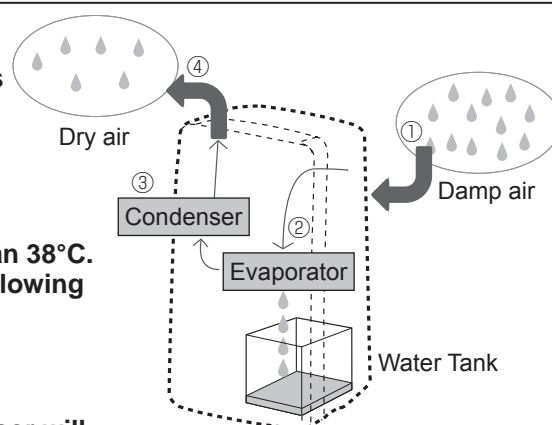

Air Purify

The Air Purifying Dehumidifier draws in room air through the air intake, circulates it through a Pre-Filter, a Active Carbon Deodorizing Filter and a HEPA Filter inside the Main Unit, and then discharges it through the air outlet. The HEPA Filter can remove 99.97% of dust particles as small as 0.3 microns that pass through the filter and also helps absorb odors. The Active Carbon Deodorizing Filter gradually absorbs odors as they pass through the filter. Some odors absorbed by the filters will break down over time, causing additional odors. Depending on usage conditions, and especially if the Main Unit is used in environments significantly more severe than a normal household, these odors may become noticeable sooner than expected. If these odors persist, replace the filters.

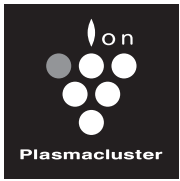

HIGH-DENSITY 7000 *

A powerful Dehumidifier with a High Concentration of Plasmacluster Ions, a high performance HEPA filter, and a active carbon deodorizing filter for Room Air Purifying, Laundry Deodorizing, Quick Drying, and Dehumidifying.

MOLD CONTROL OPERATION

It prevents the propagation of the mold by releasing Plasmacluster and dehumidified air into the room.

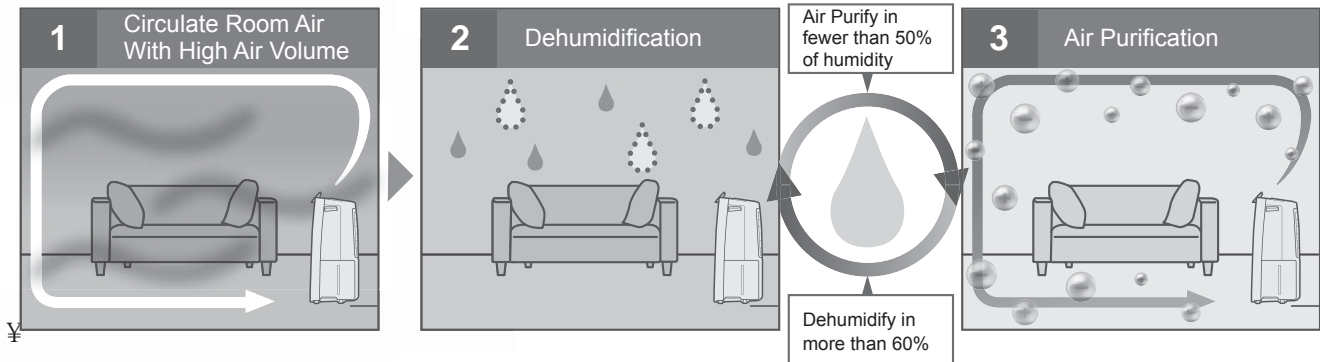

LAUNDRY Drying

Wide angle louver swings to both top and bottom / left and right wards and provides wide-area air flow.

AIR PURIFYING

It collects toxic substances such as dust, pollen, airborne mold, unpleasant odor and purify the air through SHARP's triple filters (HEPA Filter, Active Carbon Deodorizing Filter and Pre-filter)

PM2.5 Monitor

It shows the approximate amount of PM2.5 by changing the color on the indicator and numbers on the monitor.

Large Tank 4.6L

It realizes continuous dehumidification.

IMPORTANT SAFETY INSTRUCTIONS

Always follow **basic safety precautions** when using electrical appliances, including the following:

WARNING – Always observe the following to reduce the risk of electrical shock, fire, or injury:

- Read all instructions before using the Main Unit.
- Use only a 220-240 volt outlet.
- **This appliance is not intended for use by persons (including children) with reduced physical, sensory or mental capabilities, or lack of experience and knowledge, unless they have been given supervision or instruction concerning use of the appliance by a person responsible for their safety. Children should be supervised to ensure they do not play with the appliance.**
- **If the power cord is damaged, it must be replaced by the manufacturer, its service agent, a Sharp authorized Service Center or similarly qualified persons in order to avoid a hazard.**
- **Be sure to remove the power plug when draining the water, before performing maintenance, when removing and attaching and replacing the filter and when not using for a long time. Failure to do so can cause a short circuit resulting in electrical shock or fire.**
- Do not use the Main Unit if the power cord or plug is damaged or if the connection to the wall outlet is loose.
- Periodically remove dust from the plug.
- Do not insert fingers or foreign objects into the air intake or air outlet.
- When removing the power plug, always hold the plug and never pull on the cord. Failure to do so can cause a short circuit resulting in electrical shock or fire.
- When removing the Main Unit, do not damage the power cord with the casters. Failure to do so can cause electric shock, heat generation, or fire.
- Be careful not to damage the power cord, it may cause electric shock, excess heat or fires.
- Do not remove the plug when your hands are wet.
- Do not place the Main Unit near gas appliances or fireplaces.

- Only a Sharp Authorized Service Center should service this air purifying dehumidifier. Contact the nearest Service Center for any problems, adjustments, or repairs.
- Do not operate the Main Unit in rooms where aerosol insecticides are present. Do not operate the Main Unit in rooms where there is oily residue, incense, sparks from lit cigarettes, or chemical fumes in the air. Do not operate the Main Unit in places where it may get wet, such as a bathroom.
- Be cautious when cleaning the Main Unit. Strong corrosive cleansers can damage the exterior.
- When carrying the Main Unit, first remove the Water Tank, and then hold the Main Unit by the handles on both sides.
- Do not drink the water in the Water Tank.
- Do not expose the Main Unit to water. Doing so can cause a short circuit or electrical shock.
- Clean the Water Tank regularly. When the Main Unit is not in use, dispose of the water in the Water Tank. Leaving water in the Water Tank can cause mold, bacteria, and bad odors. In rare cases, such bacteria can be a health hazard.
- Check for bent hose/falling height when you want to drain continuous, and place the hose where it will securely drain.
- Keep the temperature around the hose above freezing point when using the hose. Inner water may leak in the room and dampen the furniture or may cause electric shock/leakage, fire.

NOTE - What to do if the Main Unit interferes with radio or TV reception.

If the Air Purifying Dehumidifier interferes with radio or television reception, try one or more of the following measures:

- Adjust or reposition the receiving antenna.
- Increase the distance between the Main Unit and the radio or TV.
- Connect the equipment into an outlet on a circuit different from that of the radio or TV receiver.
- Consult the dealer or a qualified radio or TV technician.

CAUTIONS CONCERNING OPERATION

- Do not block the air intake or air outlet.
- Do not place the Main Unit near or on hot objects, such as stoves or heaters, or where it may come into contact with steam.
- Always operate the Main Unit in an upright position.
- When moving the Main Unit, use the handles on both sides. Do not move the Main Unit when it is in operation.
- If the Main Unit is on easily damaged flooring, an uneven surface, or thick-piled carpet, lift it up when moving.
- When moving the Main Unit by its casters, move it slowly and in a horizontal direction.
- Turn the Main Unit off and remove the Water Tank before moving, take care not to catch your fingers.
- Do not operate the Main Unit without the filters and the Water Tank properly installed.
- Do not wash and reuse the HEPA filter and the Active Carbon Deodorizing Filter. Doing so will not improve filter performance and can also cause electric shock or operating malfunctions.
- Clean the exterior with a soft cloth only. Do not use volatile fluids or detergents. The Main Unit surface may be damaged or cracked with Benzene paint thinner or polishing powder. In addition, the sensors may malfunction as a result.
- Keep the Main Unit away from water.
- Be sure to wipe off any excess water on the outside of the Water Tank.
- Do not shake the Water Tank with holding the carrying handle.
- Avoid spilling water when removing or cleaning the Water Tank.
- Do not remove the Float.
- Do not use the detergents for maintenance of the Water Tank and Tank Cover. If cause deformation, tarnishing, cracking (water leakage).
- Do not scrub the Back Panel hard during its maintenance.

INSTALLATION GUIDELINES

- Avoid locations where the sensors are exposed to direct wind. Doing so can cause the Main Unit to malfunction.
- Avoid locations where furniture, fabrics, or other objects can come in contact with the Main Unit and interfere with the intake and outtake of air.
- Avoid locations where the Main Unit is exposed to condensation or drastic changes in temperature. Appropriate room temperature is between 4 - 38°C.
- Place the Main Unit on a level and stable surface with sufficient air circulation. When placed on heavy carpet, the Main Unit may vibrate slightly. Place the Main Unit on a level surface to avoid water leakage from the Water Tank.
- Avoid locations that generate grease or oily smoke. Doing so can cause the Main Unit exterior to crack and the sensors to malfunction.
- The dust collecting ability of the Main Unit is effective even when the Main Unit is as close to 3 cm from the wall, the surrounding walls and floor may get dirty. Please place the Main Unit at a distance from the wall. The wall directly behind the air outlet may become dirty over time. When using the Main Unit for an extended period of time at the same location, periodically clean the walls adjacent to it.

FILTER GUIDELINES

- Follow the instructions in this manual for proper filter care and maintenance.

PART NAMES

MAIN UNIT

(FRONT)

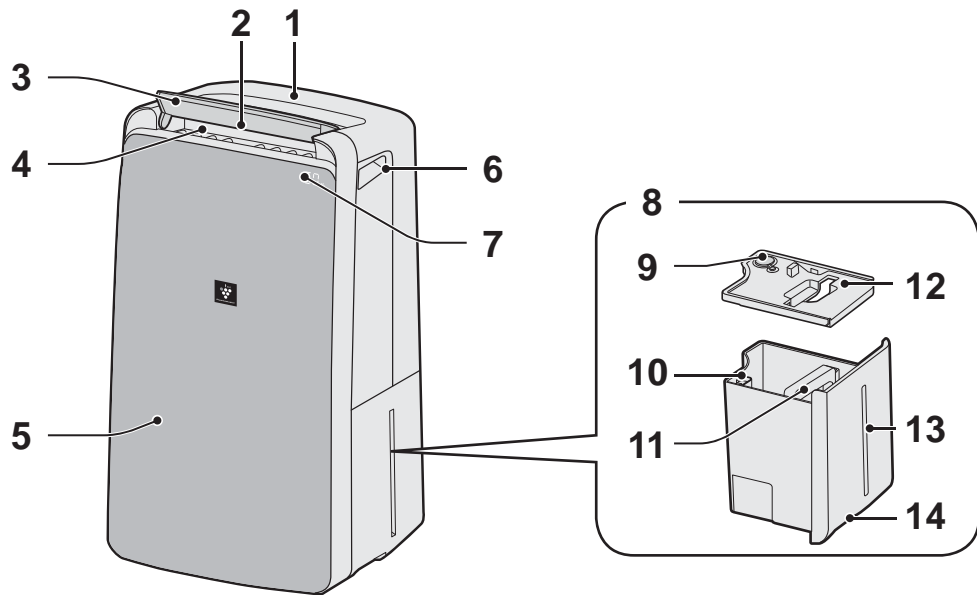

(BACK)

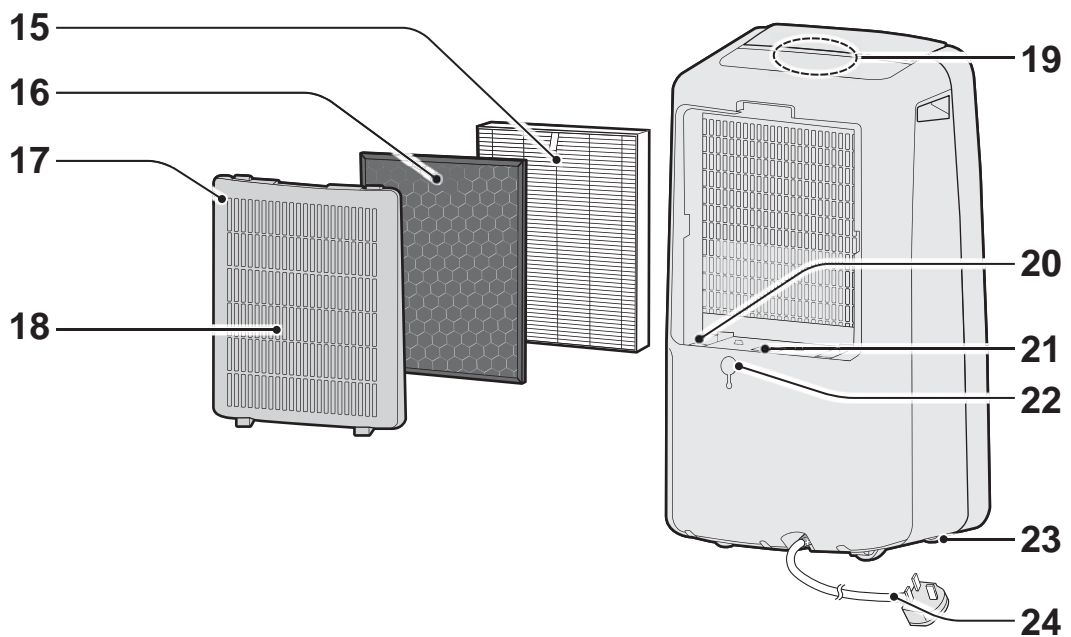

1	Operation Panel	13	Water Level Window
2	Air Outlet	14	Tank Knob
3	Vertical Louver	15	HEPA Filter
4	Horizontal Louver	16	Active Carbon Deodorizing Filter
5	Main Unit	17	Back Panel (Pre-Filter)
6	Handle (2 Locations)	18	Air Inlet
7	Front Display	19	Odor Sensor
8	Water Tank	20	Temperature/Humidity Sensor
9	Drain Outlet	21	Dust Sensitive Sensor, Sensor Filter
10	Float	22	Drainage Hole, Rubber Cap
11	Tank Handle	23	Caster (4 Locations)
12	Tank Cover	24	Power Cord, Plug

OPERATION PANEL

Press the button with "★" to start.

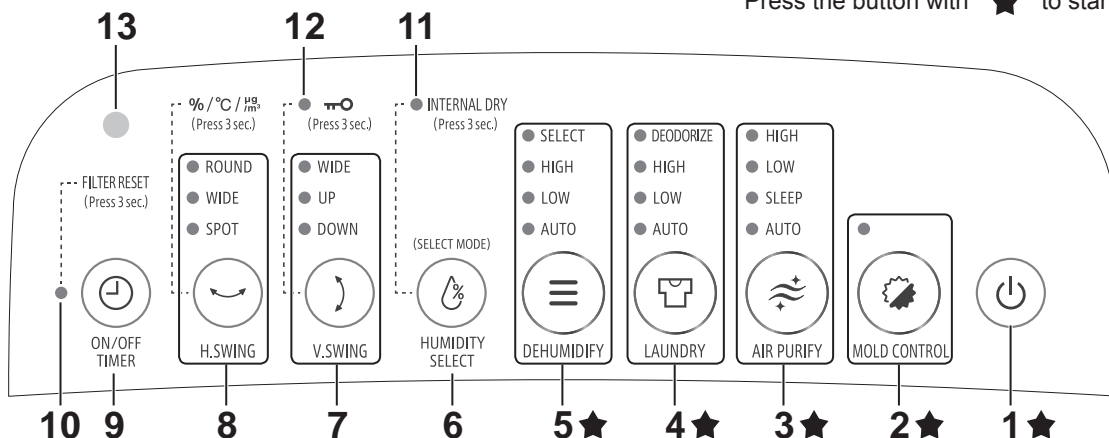

1	Power ON/OFF Button	8	H.SWING Button, Indicator Light
2	MOLD CONTROL Button, Indicator Light	9	ON/OFF TIMER Button
3	AIR PURIFY Button, Indicator Light	10	FILTER RESET Indicator Light
4	LAUNDRY Button, Indicator Light	11	INTERNAL DRY Indicator Light
5	DEHUMIDIFY Button, Indicator Light	12	Child-Lock Indicator Light
6	HUMIDITY SELECT Button	13	Light Sensor
7	V.SWING Button, Indicator Light		

FRONT DISPLAY

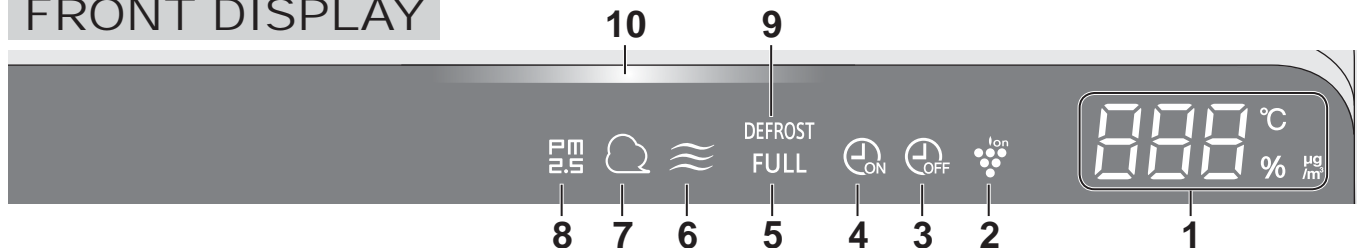

1	Humidity / Temperature / PM2.5 Monitor Indicates the approximate humidity level or temperature or PM2.5 level in the room. Humidity 20% to 90% is displayed. 20% or less 20% ↔ 55% ↔ 90% 90% or more Temperature 0°C to 50°C is displayed. -1°C or less Lo °C ↔ 25 °C ↔ H1 °C 50°C or more PM2.5 Density 10µg/m ³ to 499µg/m ³ is displayed. 9µg/m ³ or less Lo µg/m ³ ↔ 34 µg/m ³ ↔ H1 µg/m ³ 500µg/m ³ or more Timer Monitor Indicates setting time or remaining time of ON/OFF timer. HUMIDITY SELECT Monitor Indicates setting humidity of HUMIDITY SELECT mode.	6	Odor Indicator Light Indicates the Odor Sensor detects odors. OFF Orange Red Clean ←————→ Impure	
	2	Plasmacluster Ion Indicator Light (Blue)	7	Dust Indicator Light Indicates the Dust(sensitive) Sensor detects usual dust. OFF Orange Red Clean ←————→ Impure
	3	OFF Timer Indicator Light	8	PM2.5 Indicator Light Indicates the Dust(sensitive) Sensor detects microscopic dust. OFF Orange Red Clean ←————→ Impure
	4	ON Timer Indicator Light	9	DEFROST Indicator Light Indicates the Main Unit operates the DEFROST mode.
	5	Tank FULL Indicator Light (Red) Blinking when the Water Tank is Full.	10	Cleanliness Monitor Indicates the air purity of the room in 3 levels with color changes. Blue Yellow Red Clean ←————→ Impure When mold control mode It will indicate with Purple.

PREPARATION

FILTER INSTALLATION

1. Remove the Back Panel.

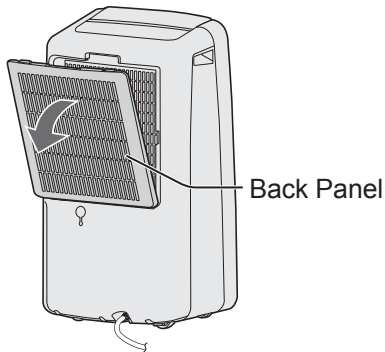

2. Remove the plastic bag from the each filter.

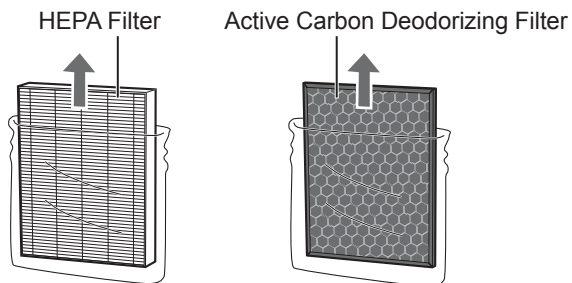

3. Install the filters in the correct order as shown.

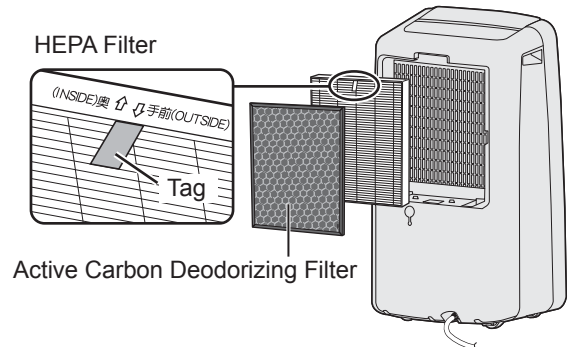

4. Install the Back Panel.

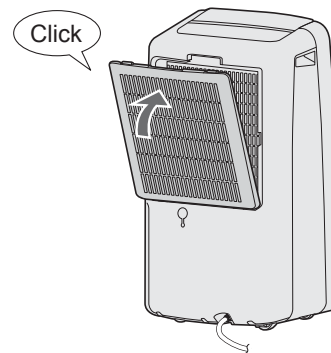

OPERATION

START / STOP

START



STOP



AUTO OFF Function

The operation will stop automatically after 12 hours in case the Main Unit has been forgotten to be turned off.

When you want to run the Main Unit for more than 12 hours continuously or drain water continuously, turn off the Auto Off function. (page 10)

The operation is not stopped while operating with "Air purification operation" and "Deodorization operation".

OPERATION

DEHUMIDIFY OPERATION

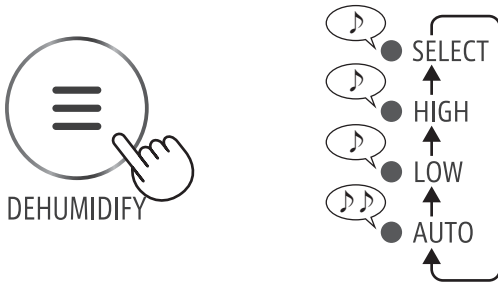

AUTO :

The humidity and the fan speed are automatically controlled by the "temperature and humidity sensor".

Temperature	4-26°C	26-38°C
Humidity	60%	55%

SELECT :

You can select your favorite humidity. (See below)

HUMIDITY SELECT

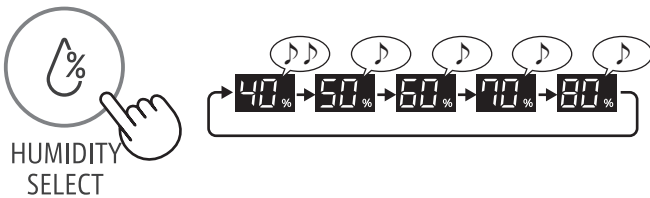

When you press the DEFUMIDIFY button to set SELECT mode, target humidity level can be changed to cycle among 60%, 70%, 80%, 40% and 50%RH in sequence.

* HUMIDITY SELECT can be works only when in SELECT mode.

LAUNDRY OPERATION

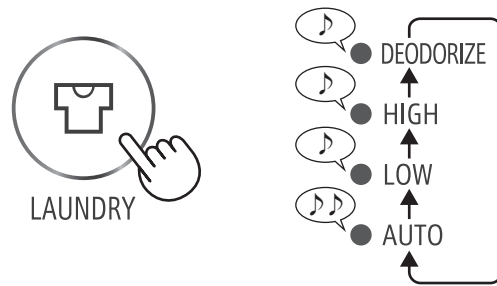

AUTO :

When you want to dry with less power consumption, the Main Unit will repeat the Dehumidifying operation and the Air Flow mode to dry the laundry.

DEODORIZE :

When you want to deodorize your laundry, the Main Unit operates at "HIGH" fan speed. Make sure the air blowing out from air outlet is directed to your laundry. It operates automatically the Plasmacluster Ion "ON".

AIR PURIFY OPERATION

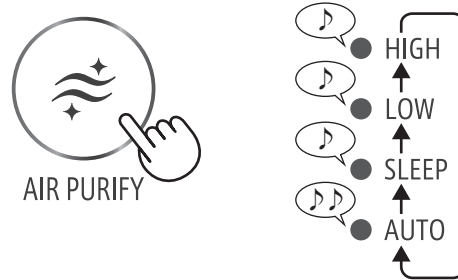

AUTO :

The fan speed is automatically changed according to amount of impurities in the air.

SLEEP :

The Main Unit will operate very quietly, and the fan speed is automatically changed depending on amount of impurities in the air. The light of Front Monitor gets off automatically.

OPERATION

MOLD CONTROL OPERATION

This mode is used to suppress the mold through strong air flow with Plasmacluster Ion.

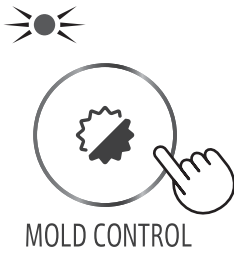

When turned ON, it firstly starts ventilation for 10 minutes with maximum air flow, and then repeats following operation.
(Cleanliness monitor shows actual operating mode. Purple: high air volume, Blue: low air volume.)
It operates automatically the Plasmacluster Ion "ON".

In a high humidity

It operates in "HIGH" mode of dehumidification until the humidity of the room decreases to the level which the mold less likely appears.



In a low humidity

Once the humidity in room becomes low, the model switches the operation with maximum airflow.

【for about 80 minutes】

(Cleanliness Monitor: blinking with Purple)

※Operating time depends on the room environment, usage conditions, and location of the Main Unit.

NOTE

- When the air in the room is purified and the humidity becomes low, the main unit operates with "Low" air flow. (Cleanliness Monitor : lighting in Blue)
- If the humidity becomes high again, it will switch to the above operation under the condition of "in a high humidity".

TIMER OPERATION

ON TIMER

The Main Unit automatically starts once the selected time passes.

(with the Main Unit OFF)

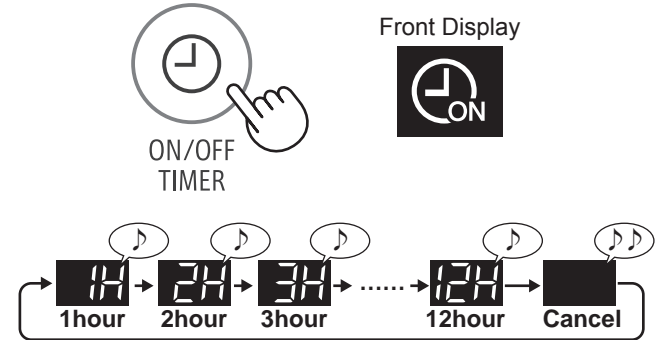

After 8 seconds, the beep sounds.

OFF TIMER

The Main Unit automatically stops once the selected time comes.

(with the Main Unit ON)

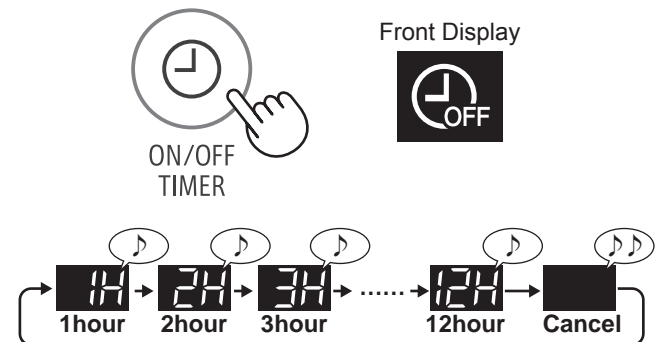

After 8 seconds, the beep sounds.

SWING LOUVER

VERTICAL SWING

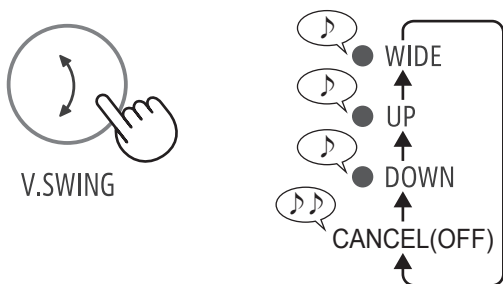

	DRY, DEODORIZE	AIR PURIFY, DEHUMIDIFY
WIDE		
UP		
DOWN		

HORIZONTAL SWING

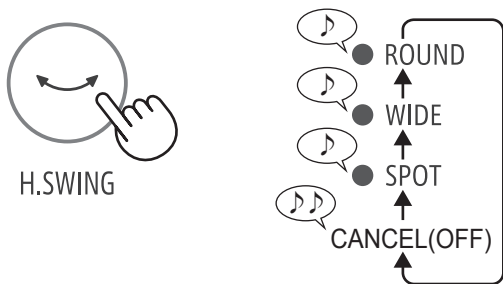

	DRY, DEODORIZE	AIR PURIFY, DEHUMIDIFY
ROUND		
WIDE		
SPOT		

INTERNAL DRY OPERATION

When you set the Internal Dry operation, the Main Unit automatically operate the Air Flow mode it for approximate 90 minutes after stopping.

(with the Main Unit ON)

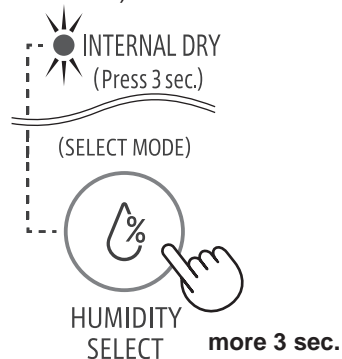

CHILD LOCK

The operation of the operation panel will be locked.

ON



CANCELLATION

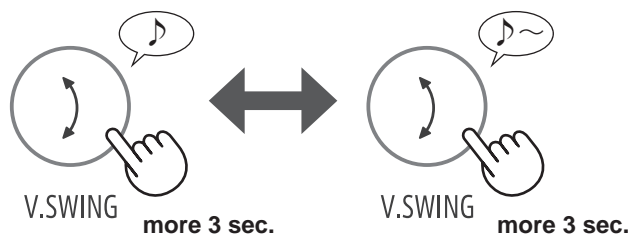

SELECTING DISPLAY

(with the Main Unit ON)

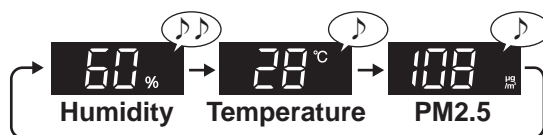

After 8 seconds, the beep sounds.

OPERATION

HOW TO CHANGE VARIOUS SETTING

You can change the functions in the table "Type of setting".

1. Turn off the Main Unit power.



3. Select "Function number".

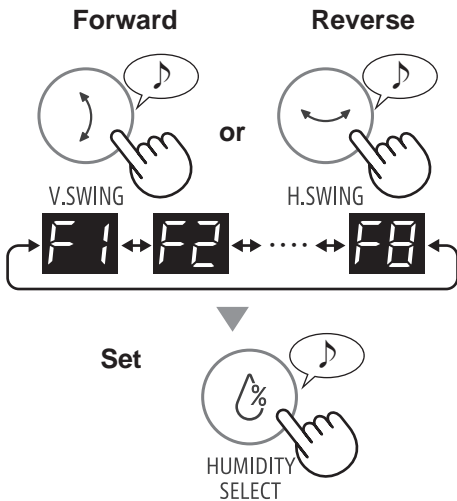



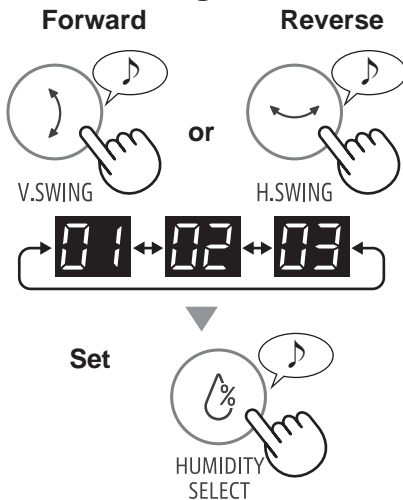





4. Select "Setting number".



5. Press Power ON/OFF Button to finish the setting mode.



Type of setting

Function	Setting						
Auto Restart If the Main Unit is unplugged or if there is a power failure, the Main Unit will resume operation with the previous settings after power is restored.	 01 Cancellation 02 ON (default)						
Sound Indicator Setting You can turn off the beeping sound when the Main Unit stops operating as follows. When the Main Unit stops operating as the following situation, you can turn off the beeping sound.	 01 Cancellation 02 ON(default)						
Light Control You can select the brightness of the Front Display.	 01 Turn off When set to "Turn off", the "Darker" light illuminates for 8 seconds after operation starts and then the light turns off. The FULL Light flashes darker only when the Water Tank is full. 02 Darker 03 Auto (default) Light automatically switches based on room brightness. <table border="1" data-bbox="1181 1299 1468 1388"> <thead> <tr> <th>Room</th> <th>Front Display</th> </tr> </thead> <tbody> <tr> <td>bright</td> <td>brighter</td> </tr> <tr> <td>dark</td> <td>darker</td> </tr> </tbody> </table> * When "SLEEP" mode operate; Room is bright : light is darker Room is dark : light is OFF	Room	Front Display	bright	brighter	dark	darker
Room	Front Display						
bright	brighter						
dark	darker						
PLASMACLUSTER ION ON/OFF	 01 OFF 02 ON (default)						
Auto Off The operation will stop automatically after 12 hours in case the Main Unit has been forgotten to be turned off.	 01 Cancellation 02 ON (default)						
Adjusting Sensor Sensitivity (F6-F8)							
Light Sensor	 01 Low						
Dust(sensitive) Sensor	 02 Standard (default)						
Odor Sensor	 03 High						

* Light Sensor : Default is "Middle".
 Dust(sensitive) and Odor Sensor : Default is "High".

HOW TO DRAIN

When the Water Tank is Full, the TANK FULL Indicator Light is blinking.



1. Remove the Water Tank.

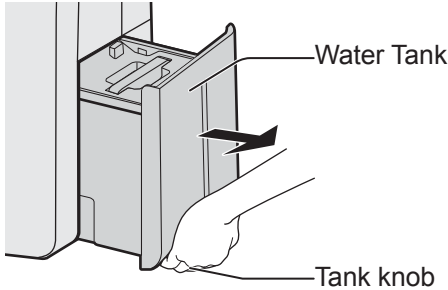

2. Dispose the water of the Water Tank.

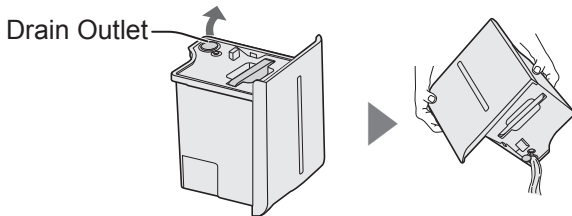

3. Install the Water Tank.

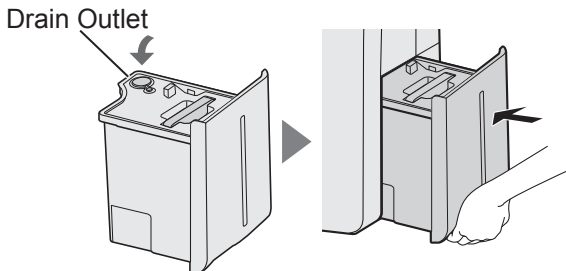

NOTE

- Clean the Water Tank about once a week. If you do not clean the Water Tank, it can cause mold, bacteria, and bad odors.

When you want to drain continuous

How to pipe the hose

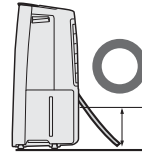

Always have the tip slanted.

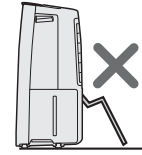

Do not bend.

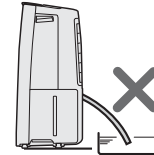

Under cold weather, do not put the hose into the water.

1. Remove the Plug.



2. Remove the Water Tank and the Rubber Cap.

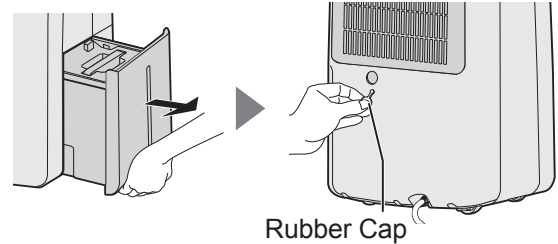

3. Set the hose in the Back Hole.

Commercial hose :
inner diameter 15mm
(outer diameter up to
21mm)

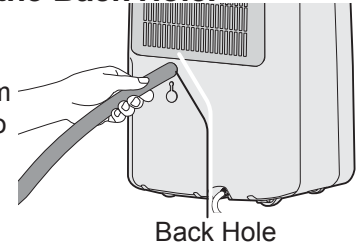

4. Insert the hose firmly to bottom in the Drain Hole.

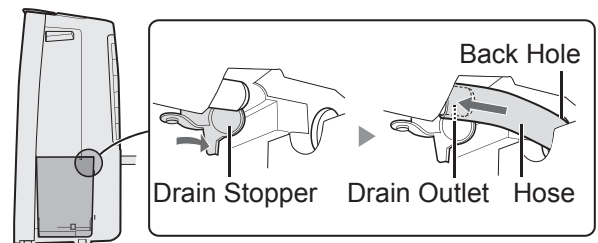

5. Install the Water Tank.

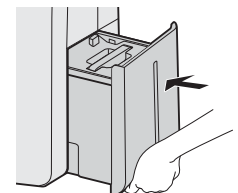

CARE AND MAINTENANCE

WATER TANK (About once a week)

1. Remove the Tank Cover, and dispose of the water.

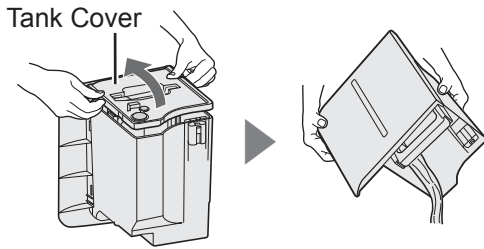

2. Wash the inside of the Water Tank.

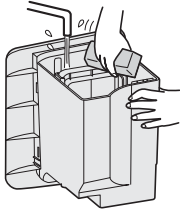

NOTE

- If the dirt is heavy, please dissolve neutral detergent in lukewarm water and wash.

3. Dry the tank with a soft cloth.

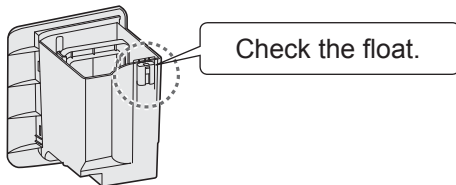

4. Install the Tank Cover.

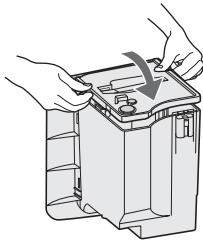

BACK PANEL / SENSOR (About once every 2 weeks)

Remove the dust gently with a cleaning tool such as a vacuum cleaner.

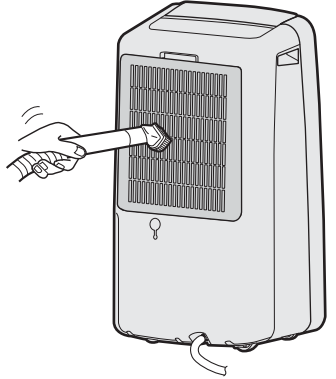

NOTE How to clean and remove a heavy dirt.

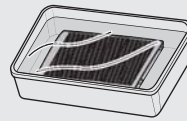

Back Panel

1. Add a small amount of neutral detergent to water and soak for about 10 minutes.

CAUTION

- Do not give excessive pressure to the back panel when scrubbing it.
2. Rinse off the neutral detergent with clean water.
3. Completely dry the filter in a well-ventilated area.

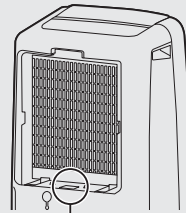

Sensor Filter

1. Remove the Back Panel.
2. Remove the sensor filter.
3. If the sensor filter is very dirty, wash it with water and dry it thoroughly.

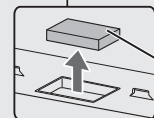

Sensor Filter

MAIN UNIT (About once a month)

Wipe with a dry, soft cloth.



Do not wash with water.

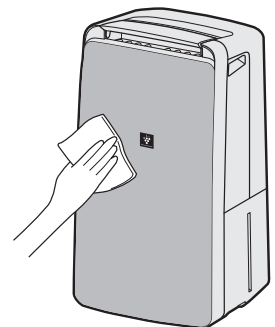

FILTER INDICATOR

The FILTER RESET Indicator light will turn on after approximately 720 hours operating. (30 days × 24 hours = 720 hours)

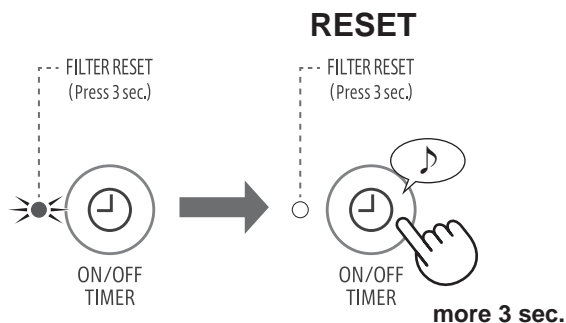

This is a reminder to perform the maintenance described below. After performing maintenance, reset the FILTER RESET Indicator.

HEPA FILTER / Active Carbon Deodorizing Filter (About once a month)

Remove the dust on the HEPA Filter and Active Carbon Deodorizing Filter.

CAUTION

Do not wash the filters. Do not expose to sunlight. (Otherwise these filters may lose efficacy.)

HEPA FILTER

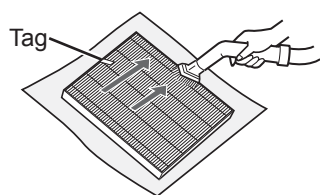

Clean only the tagged surface. Do not clean up the opposite surface. The filter is fragile, so be careful not to give too much pressure.

Active Carbon Deodorizing Filter

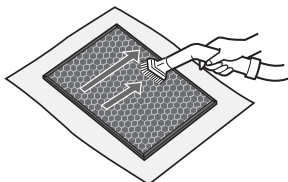

Both surfaces can be cleaned. The filter may be broken if being too much pressure is applied on it, so please handle it with care.

Some odors absorbed by the filters will break down over time, causing additional odors. Depending on usage conditions, and especially if the Main Unit is used in environments significantly more severe than a normal household, these odors may become noticeable sooner than expected. Replace the filter in those cases or if dust is unable to be removed after maintenance.

FILTER REPLACEMENT

LIFE OF FILTERS

Filter life varies depending on the room environment, usage conditions, and location of the Main Unit. Lifespan of HEPA filter and Active Carbon Deodorizing Filter and replacement suggestions are based on purifying a room in which 5 cigarettes are smoked per day and the Main Unit's dust collection and deodorizing performance has declined to half the level of a new filter.

We recommend replacing the filter more frequently if the Main Unit is used in conditions significantly more severe (PM2.5 etc.,) than a normal household.

•HEPA Filter

About 10 years after opening

•Active Carbon Deodorizing Filter

About 10 years after opening

Replacement Filter Model

Consult your dealer when purchasing a replacement filter.

HEPA Filter(1 unit)

FZ-J20HFE



Active Carbon Deodorizing Filter(1 unit)

FZ-J20DFE

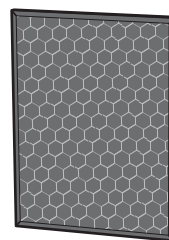

Disposing of filters

Dispose of used filters according to local laws and regulations.

HEPA Filter material:

- Polypropylene
- Polyethylene

Active Carbon Deodorizing Filter material:

- Polypropylene
- Polyethylene
- Activated carbon

CARE AND MAINTENANCE

When storing for a long period (not in use)

1. Operate the INTERNAL DRY OPERATION.

① Start operation.



② Select the Internal Dry Operation.

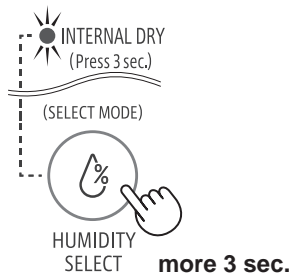

③ Stop Operation.



*Start the Internal Dry Operation, and stop automatically after approximate 90 minutes.

2. Dispose tank water and care the Main Unit.

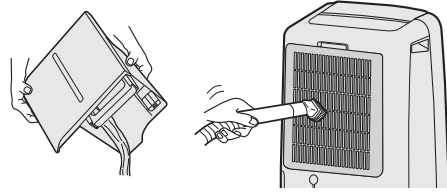

3. Store in a dry place away from direct sunlight.

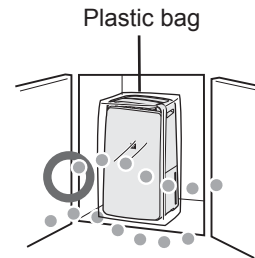

TROUBLESHOOTING

Before contact for service, check the following points to make sure that the problem is not a Main Unit malfunction.

The room becomes hot.

- The Main Unit generates heat during LAUNDRY DRY operation and DEHUMIDIFY operation and the room temperature will rise. Warm air will be come out from the air outlet, but this is normal and does not indicate a problem with the Main Unit.

The Main Unit does not dehumidify.

- The performance of dehumidification level varies with the size, structure, temperature and humidity level of the room. When room temperature or humidity level is low, the performance will become low in general.
- Check whether the Back Panel is clean.
- Check whether the air outlet or air inlet is not blocked.

Sounds

- The Main Unit may make clicking or ticking sounds when it is generating ions.
- The Main Unit may seem rather loud for the first 2 to 3 minutes when the Main Unit is turned on. This is the sound of the compressor starting-up and is perfectly normal.
- A soft, swishing noise can be heard immediately after the Main Unit is turned on or off, and also during operation. This is the sound of the refrigerant flowing inside the Main Unit.

The sound is too loud.

- The Main Unit will sound loudly for the first few seconds upon power-on when the room temperature is low.
- Check whether the Main Unit is placed on a stable and level floor.
- Check whether the Back Panel is not clogged.

Odor and smoke persists.

Air discharged from the Main Unit has an odor.

- Check whether the filters are extremely dirty.
- Clean or replace the filters.

The Cleanliness Monitor light is not blue even when the air is clean.

- Dirty or clogged dust(sensitive) sensor openings interfere with sensor operation. Gently clean the sensor filter or the back panel.
- When the Main Unit is operating MOLD CONTROL operation, the light indicates the operation mode of the MOLD CONTROL operation.

The Main Unit does not operate when cigarette smoke is in the air.

- Make sure the Main Unit is installed in a location in which the sensors can detect cigarette smoke.
- Check whether the dust(sensitive) sensor openings are blocked or clogged. If they are blocked or clogged, clean the sensor filter or the back panel.

The FILTER RESET Indicator Light is on.

- Whenever after performing maintenance or replacing the filters, connect the power cord to an outlet and then press the ON/OFF Timer Button. (page 13)

There is a discrepancy between the Main Unit's Humidity Monitor and another hygrometer in the room.

- There is a difference in the humidity level within the same room.
- The sensor have different measurement parameters.
- If the monitor indicates temperature or PM2.5 level, switch the display by pressing the DISPLAY SELECT button. (page 9)

The Main Unit PM2.5 monitor does not match weather report or other local PM2.5 data.





- Ambient / Indoor air condition or home environment vary in each place. This may cause the discrepancy of each reported number. Please take note PM2.5 monitor shows reference numbers.

The water leaks.

- Check whether the main unit is placed horizontally.
- When draining continuous, check whether the hose is inserted all the way seated.

ERROR DISPLAY

If error occurs repeatedly, contact the Sharp Service Center.

	<ul style="list-style-type: none"> • If the Water Tank is full, drain the water. • If the Water Tank is not properly placed, place the Water Tank correctly.
	<ul style="list-style-type: none"> • The Main Unit is operating with the DEFROST mode.
	<ul style="list-style-type: none"> • Laundry DRY (Auto) operation has completed, and the operation has stopped.
	<ul style="list-style-type: none"> • The operation has stopped with the Auto Off function.
	<ul style="list-style-type: none"> • Unplug the Main Unit, wait one minute, and then plug the Main Unit in again.

SPECIFICATIONS

Dehumidifying Specifications

Model		DW-J27FA	DW-J20FA
Power Supply		220V-240V/50Hz	
Dehumidifying Capacity ※ 1	30°C/80%RH	27 L/day	20 L/day
	26.7°C/60%RH	16 L/day	12.5 L/day
Power Consumption ※ 2	30°C/80%RH	420 W	340 W
	26.7°C/60%RH	345 W	260 W
Standby Power ※ 3		0.9 W	0.9 W
Recommended Room Size for Dehumidifying ※ 4		33-67 m ²	26-52 m ²
Water Tank Capacity		Approx. 4.6 L	
Cord Length		Approx. 2 m	
Dimensions		359 mm(W) × 303 mm(D) × 665 mm(H)	359 mm(W) × 301 mm(D) × 665 mm(H)
Weight		17.8 kg	16.7 kg

Air Purifying Specifications

Model	DW-J27FA		DW-J20FA	
Recommended Room Size for Air Purifying ※ 4	32 m ²		28 m ²	
Recommended Room Size for High density Plasmacluster ion ※ 5	33 m ²		23 m ²	
Fan Speed Adjustment	LOW	HIGH	LOW	HIGH
Fan Speed	90 m ³ /h	306 m ³ /h	90 m ³ /h	258 m ³ /h
Rated Power	7.3 W	67 W	7.3 W	50 W
Noise Level	29 dB	53 dB	29 dB	51 dB

- ※ 1 The amount of humidity that a dehumidifier removes from the air in a day when room temperature and relative humidity are kept at 30°C/80%RH and 26.7°C/60%RH respectively.
- ※ 2 The consumption value when fan speed reaches the highest.
- ※ 3 When the Main Unit's power plug is inserted in a wall outlet it consumes the standby power in order to operate electrical circuits.
- ※ 4 Based on standards of JEMA.
- ※ 5 Recommended Room Size for High density Plasmacluster ion in which approximately 7000 ions per cubic centimeter can be measured in the center of the room when the Main Unit is placed next to a wall, is running at LAUNDRY Operation "DEODORIZE" mode settings, and is at a height of approximately 1.2 meters from the floor.

MEMO

SHARP

SHARP CORPORATION

OSAKA, JAPAN